

Weigh Module

FEATURES

- Capacity range: 50, 100, 200, 300, and 500 kN (11.2K, 22.4K, 44.9K, 67.5K, and 112.4K lb)
- Easy installation
- Moveable load point
- Withstands very high lateral forces
- Extremely accurate and rugged
- ATEX, IECEx, FM, CSA certified for hazardous locations



APPLICATIONS

- Large silo and storage bins
- Reactor and mixing vessels
- Conveyor belts
- High-capacity force measurement systems
- Web tension

DESCRIPTION

The KIS-1 load cell has several features that clearly distinguish it from other load cells. It is easy to install and extremely accurate, even when subjected to dynamic process forces and severe environmental conditions. All KIS load cells can be ATEX, IECEx, FM, CSA certified for use in explosive atmospheres.



OUTLINE DIMENSIONS

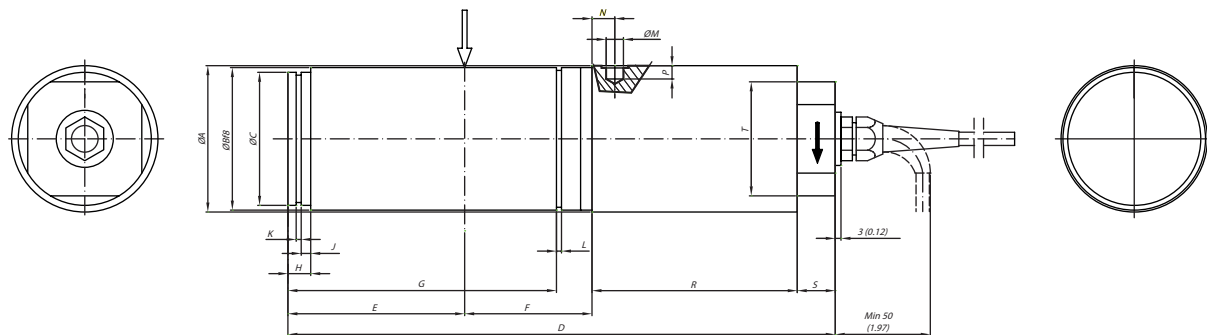

RANGE kN (lb)	ØA	ØB	ØC	D	E	F	G	H	J	K	L	ØM	N	P	R	S	T
50 (11.2k)	77 (3.03)	75 (2.95)	70 (2.76)	288 (11.34)	95 (3.74)	65 (2.56)	141.3 (5.56)	12 (.47)	5 (.20)	2.65 (.10)	2.65 (.10)	9.1 (.36)	12 (.47)	7 (.28)	108 (4.25)	20 (.79)	60 (2.36)
100 (22.4k)	92 (3.62)	90 (3.54)	82 (3.23)	312 (12.28)	109 (4.29)	65 (2.56)	155.4 (6.12)	15 (.59)	6 (.24)	2.65 (.10)	3.15 (.12)	12.6 (.50)	15 (.59)	8 (.31)	118 (4.65)	20 (.79)	70 (2.76)
200 (44.9k)	101 (3.98)	100 (3.94)	90 (3.54)	343 (13.50)	130 (5.12)	65 (2.56)	175.8 (6.92)	15 (.59)	6 (.24)	3.15 (.12)	3.15 (.12)	15.7 (.62)	17 (.67)	8.5 (.33)	128 (5.04)	20 (.79)	80 (3.15)
300 (67.5k)	101 (3.98)	100 (3.94)	90 (3.54)	343 (13.50)	130 (5.12)	65 (2.56)	175.8 (6.92)	15 (.59)	6 (.24)	3.15 (.12)	3.15 (.12)	15.7 (.62)	17 (.67)	8.5 (.33)	128 (5.04)	20 (.79)	80 (3.15)
500 (112.4k)	142 (5.59)	140 (5.51)	130 (5.12)	447 (17.60)	168 (6.61)	75 (2.95)	212.8 (8.38)	35 (1.38)	20 (.79)	4.15 (.16)	4.15 (.16)	15.7 (.62)	27 (1.06)	8.5 (.33)	177 (6.97)	27 (1.06)	80 (3.15)

Dimension shown in mm (in)

Weigh Module

OUTLINE DIMENSIONS cont.

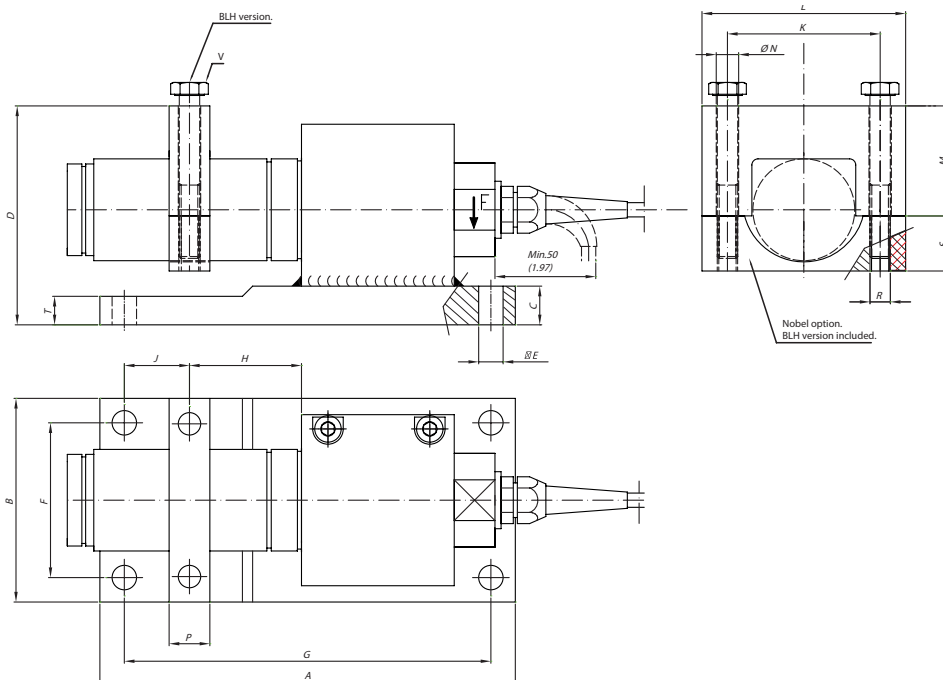

RANGE kN (lb)	A	B	C	D	ØE	F	G	H	J	K	L	M	ØN	P	T	R	S
50 (11.2k)	280 (11.02)	150 (5.91)	30 (1.18)	152 (5.98)	16 (0.63)	115 (4.53)	245 (9.65)	65 (2.56)	45,5 (1.79)	115 (4.53)	150 (5.91)	72 (2.83)	18 (0.71)	29 (1.14)	30 (1.14)	M16 M16	43 (1.69)
100 (22.4k)	310 (12.20)	170 (6.69)	40 (1.57)	173 (6.81)	22 (0.87)	130 (5.12)	270 (10.63)	65 (2.56)	63 (2.48)	126 (4.96)	160 (6.30)	85 (3.35)	22 (0.87)	39 (1.54)	39 (1.02)	M20 M20	50 (1.97)
200 (44.9k)	340 (13.39)	180 (7.09)	50 (1.97)	199 (7.83)	25 (0.98)	140 (5.51)	300 (11.81)	65 (2.56)	71 (2.80)	146 (5.75)	190 (7.48)	95 (3.74)	25 (0.98)	49 (1.93)	32 (1.26)	M24 M24	57 (2.24)
300* (67.5k)	340 (13.39)	180 (7.09)	50 (1.97)	199 (7.83)	25 (0.98)	140 (5.51)	300 (11.81)	65 (2.56)	71 (2.80)	175 (6.89)	220 (9.02)	105 (4.13)	26 (1.02)	53 (2.09)	32 (1.26)	M24 M24	56 (2.20)
500* (112.4k)	480 (18.90)	280 (11.02)	60 (2.36)	315 (12.40)	33 (1.30)	220 (8.66)	420 (16.54)	75 (2.95)	108 (4.25)	240 (9.45)	300 (11.81)	150 (5.91)	26 (1.02)	70 (2.76)	60 (2.36)	M24 M24	91 (3.58)

* Provided with loading ring

RANGE kN (lb)	V
50	M16-2X120 (4.724) LG
100	M20-2.5X140 (5.512) LG
200	M24-3X160 (6.299) LG
300	Not available
500	Not available

Dimension shown in mm (in)

Weigh Module

SPECIFICATIONS	
PARAMETER	VALUE
PERFORMANCE	
Rated load (RL)	50, 100, 200, 300, 500 kN
Combined error (terminal)	±0.03% RO
Repeatability	0.01% RO
Overload,* safe	200% RL, 150% RL for 300 kN and 500 kN
Overload,* ultimate	300% RL, 200% RL for 300 kN
Uplift, safe	70% RL
Uplift, ultimate	85% RL
Side load,* safe	100% RL, 50% RL for 300 kN and 500 kN
Side load,* ultimate	200% RL, 100% RL for 300 kN and 500 kN
Input voltage, recommended	10 VDC or VAC
Input voltage, maximum	18 VDC or VAC
Input resistance	350 Ω ±3 Ω
Output resistance	350 Ω ±0.5 Ω
Rated output (RO)	2.040 mV/V
Tolerance of RO	±0.1% RO
Zero balance	±1% RO
Tolerance of shunt calibration values	0.1% of value; actual output defined on unit calibration sheet
Creep at RL after 30 minutes	±0.04% RL
Temperature range (wider temperature range available upon request)	-40 to +105°C -40 to +220°F
Temperature effect, on output (-10°C to +50°C)	±0.0015% of output/°C ±0.0008% of output/°F
Temperature effect, on zero balance (-10°C to +50°C)	±0.003% RO/°C ±0.0017 % RO/°F
Insulation resistance at 200 VDC	>4 GΩ
Material: load cell, 50 kN	Stainless steel (Nobel version), yellow chromate steel (BLH version)
Material: load cell, 100–500 kN	Yellow chromate steel, stainless steel as an option
Material: bracket, yoke and tilt guard	Yellow chromate steel, stainless steel as an option
Electrical connection	10m shielded four conductor cable
Degree of protection	IP67
APPROVALS	
ATEX, IECEx, FM, CSA certified versions are available upon request. For details contact blhnobel@vpgsensors.com.	

* Referring to recommended loading point

BLH Nobel is continually seeking to improve product quality and performance. Specifications may change accordingly.



Disclaimer

ALL PRODUCTS, PRODUCT SPECIFICATIONS AND DATA ARE SUBJECT TO CHANGE WITHOUT NOTICE.

Vishay Precision Group, Inc., its affiliates, agents, and employees, and all persons acting on its or their behalf (collectively, "VPG"), disclaim any and all liability for any errors, inaccuracies or incompleteness contained herein or in any other disclosure relating to any product.

The product specifications do not expand or otherwise modify VPG's terms and conditions of purchase, including but not limited to, the warranty expressed therein.

VPG makes no warranty, representation or guarantee other than as set forth in the terms and conditions of purchase. **To the maximum extent permitted by applicable law, VPG disclaims (i) any and all liability arising out of the application or use of any product, (ii) any and all liability, including without limitation special, consequential or incidental damages, and (iii) any and all implied warranties, including warranties of fitness for particular purpose, non-infringement and merchantability.**

Information provided in datasheets and/or specifications may vary from actual results in different applications and performance may vary over time. Statements regarding the suitability of products for certain types of applications are based on VPG's knowledge of typical requirements that are often placed on VPG products. It is the customer's responsibility to validate that a particular product with the properties described in the product specification is suitable for use in a particular application. You should ensure you have the current version of the relevant information by contacting VPG prior to performing installation or use of the product, such as on our website at vpgsensors.com.

No license, express, implied, or otherwise, to any intellectual property rights is granted by this document, or by any conduct of VPG.

The products shown herein are not designed for use in life-saving or life-sustaining applications unless otherwise expressly indicated. Customers using or selling VPG products not expressly indicated for use in such applications do so entirely at their own risk and agree to fully indemnify VPG for any damages arising or resulting from such use or sale. Please contact authorized VPG personnel to obtain written terms and conditions regarding products designed for such applications.

Product names and markings noted herein may be trademarks of their respective owners.

Copyright Vishay Precision Group, Inc., 2014. All rights reserved.